

AMERICAN
TECHNICAL
CERAMICS

POWER CAPACITOR ASSEMBLIES



 THE
ENGINEERS'
CHOICE®



ISO 9001
REGISTERED
COMPANY

Overview



About ATC Power Assemblies

ATC standard & custom Power Assemblies are fabricated from PARALLEL and SERIES combinations of industry-respected ATC catalog products. Customer requirements are addressed by a variety of computer matching and assembly techniques which have enabled ATC to extend voltage, current, ESR, Q, and tolerance parameters beyond what is normally available in the industry.

ATC Power Assemblies offer distinct advantages over purchasing standard components “in the general ballpark” and trying “hit & miss” approaches to configure & match these in a circuit environment. ATC’s strong tradition of quality and customer service enables us to work closely with design engineers to meet critical specifications.

Performance Advantages

- High Operating Voltage
- High Operating Current
- Extended Capacitance
- Tighter Tolerances
- High Reliability
- High Q
- Ultra-low ESR

Typical Applications

- High Power RF
- Medical Electronics
- Broadcast
- Industrial Applications
- Semiconductor Manufacturing
- High Magnetic Environments
- Inductive Heating



Benefits of Utilizing Power Assemblies

- **New price structure allows for more cost-effective assemblies.**
- **Reduced Assembly Steps / Handling Costs:**
Combinations of capacitors pre-packaged in manageable mechanical configurations for customer specific “drop-in” applications – Fits Every Time.
- **Enhanced Reliability:**
Overall elements and assemblies are 100% pre-tested to customer’s electrical requirements: – Capacitance – Q – IR – DWV (to 10kV max).
- **Reduced Purchasing Logistics:**
– Reduced inventory requirements in matched assemblies
– Elimination of excess, wasted parts
- **Reduced Technical Labor:**
Alleviate need for engineering and technician resources in selecting electrically matched elements.
- **Guaranteed Performance:**
ATC guarantees electrical / mechanical performance on an assembly level every time.
- **Achieve Non-Standard Values and Ultra-Tight Tolerances:**
ATC will “mix and match” values from our extensive inventory via computer matching programs to achieve any capacitor value specified by the designer.

ATC’s products provide many advantages to customers requiring multiple component capacitive sets and assemblies. Call ATC – or your Local ATC representative to reach one of our Power Assembly Applications Engineers to discuss your specific requirements today.

Capabilities

ATC offers both standard designs and custom products, including matched sets and voltage dividers. ATC Power Assemblies are available in two categories: Standard and Custom.



Standard Assemblies

are those configurations most frequently specified by customers. Although it is not possible to stock finished assemblies, fabrication time is short, as the lead configurations and necessary tooling are readily available.

Custom Assemblies

For those instances where our Standard Assemblies cannot be used, ATC will assist in the design of special configurations to meet customer needs. Special capacitor groupings and lead configurations can be provided to customer configurations.



Non-Magnetic Assemblies

To maintain assembly performance in high magnetic field environments, ATC provides a catalog option for termination materials with magnetic immunity.



Matched Sets

For designs that require close tolerance non-standard capacitance values, ATC offers parallel or series sets to match 2 or more capacitors to the exact value required.

Voltage Dividers

For those designs requiring capacitive voltage dividers, ATC can provide a set of capacitors that will satisfy customers' design parameters.

Assemblies

Typical Mechanical Configurations

The following configurations represent frequently ordered catalog assemblies offered by ATC. The drawings depict a variety of mounting configurations, circuit attachment options and series/parallel combinations.

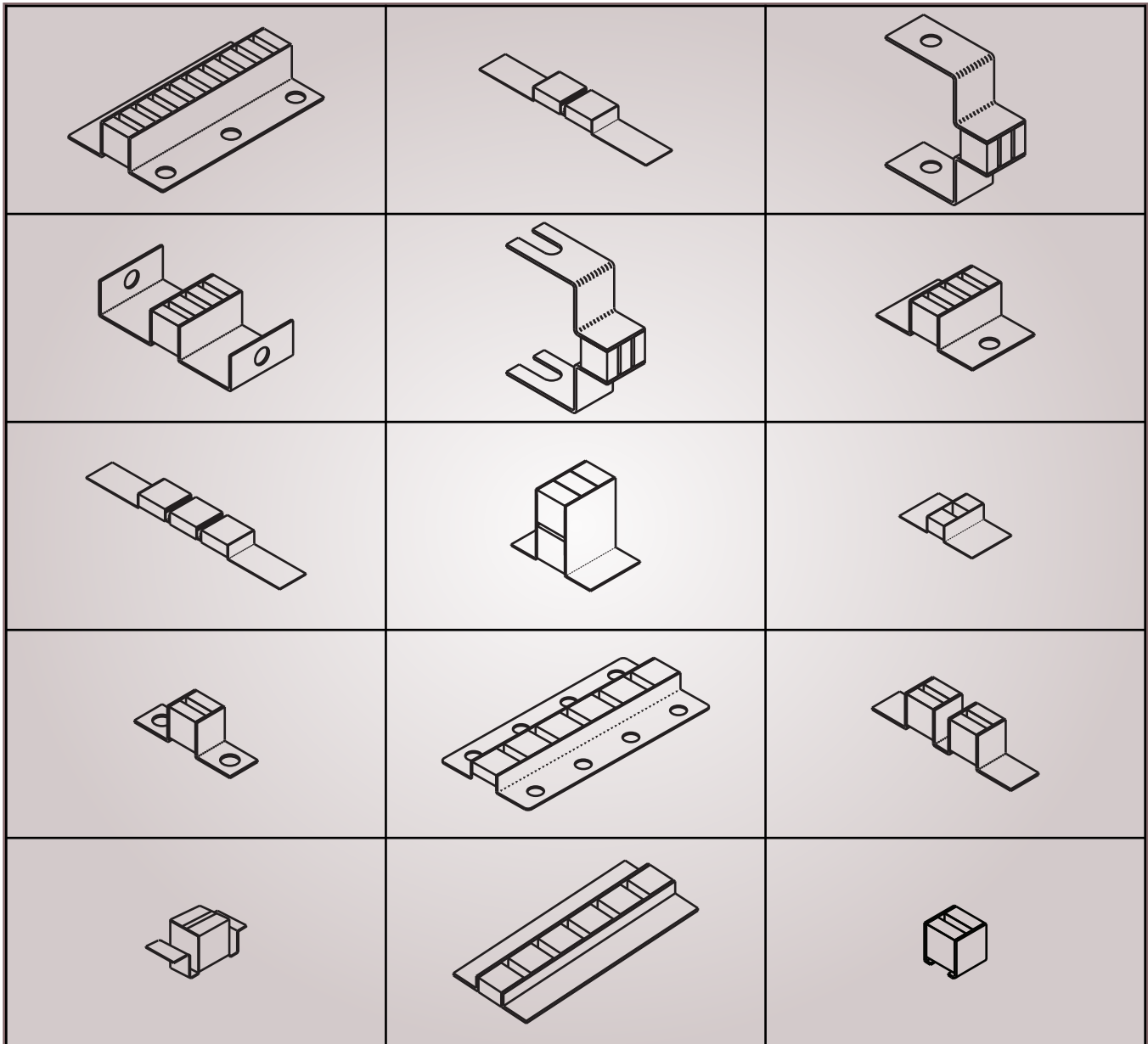

Custom Packaging

ATC's **Applications Engineering** and **Mechanical Engineering** personnel are available to support your specific packaging needs.

Call +1-631-622-4700 to speak directly to one of our on-staff engineers.

Standard Assembly Configurations

ATC offers leaded assemblies that extend the capacitance, voltage and current parameters of our standard multilayer ceramic product line. As our standard products are the building blocks for each assembly, ATC's proven reliability, electrical and mechanical parameters become part of each assembly.

Assemblies of parallel grouped capacitors not only increase the capacitance but will exhibit ultra-low ESR. Assemblies of series grouped capacitors will allow both tighter tolerances and higher working voltages. Combinations of Parallel and Series assemblies can realize an increase in both capacitance and voltage rating. Assemblies can be composed of multiple capacitors in horizontal, vertical or multi-level mounting configurations.



All leaded assemblies are RoHS compliant.

Parallel Assemblies

Standard Design Parameters	B Case	C Case	E Case
No. of caps	2	2 - 6	2 - 8
Lead Type	L Bracket	L Bracket	L Bracket
Lead Material	Silver	Silver	Silver or Copper
Lead Thickness	.004 or .010 (0.10 or 0.25)	.004 or .010 (0.10 or 0.25)	.010 or .020 (0.25 or 0.51)
Lead Length (max.)	0.5 (12.7)	0.75 (19.1)	2.0 (50.8)
No. holes (max.)	None	1 per lead	1 per lead
Mtg Configuration	Horizontal/Vertical	Horizontal/Vertical	Horizontal/Vertical
Capacitor Spacer (typ.)	.050 or .070 (1.27 or 1.78)	.050 or .070 (1.27 or 1.78)	.090 (2.29)

inches (mm)

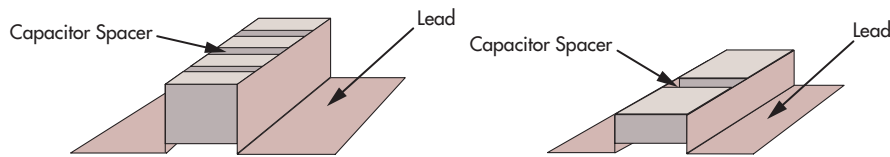

Series Assemblies

Standard Design Parameters	C Case	E Case
No. of caps	2 - 3	2 - 3
Lead Type	L Bracket	L Bracket
Lead Material	Silver	Silver
Lead Thickness	.010	.010
Lead Length (max.)	0.75 (19.1)	1.0 (25.4)
No. holes (max.)	1 per lead	1 per lead
Mtg Configuration	Horizontal	Horizontal
Capacitor Spacer (typ.)	.050 (1.27)	.050 (1.27)

inches (mm)

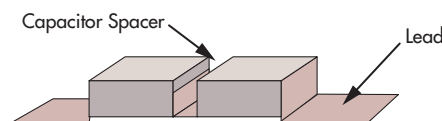

Part Number Code

ATC Power Assembly Part Number Code

The part number consists of a base description plus an ATC drawing number. The final design will be based on customer requirements. All leaded assemblies are RoHS compliant .

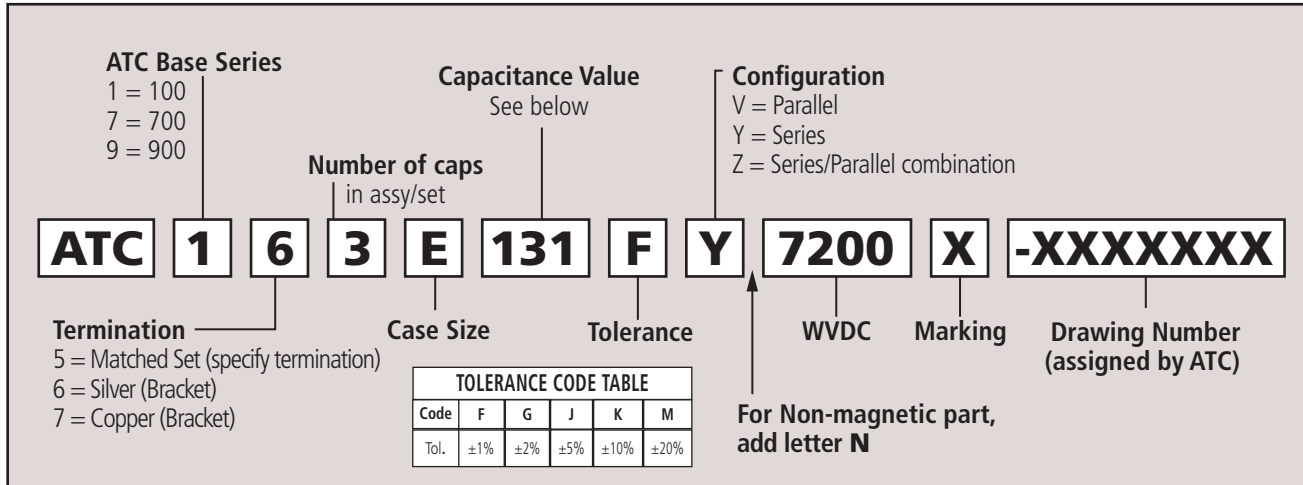

Capacitance Value:

For capacitor values requiring only 2 significant digits:

3 digit code consists of 2 significant digits and a multiplier.
The R is used for decimal values.

e.g. ATC 172E151JV3600X-SK1103D

Copper bracket assembly with two 100E pieces in parallel, with an end value of 150 pF, a WVDC of 3600 V and marked with part number code.

For capacitor values requiring 3 significant digits:

3 digit code consists of first two significant digits and the third consisting of a letter representing the values 1 to 9.

e.g. ATC 163E13EFYN10200X-SK1028A

A = 1, B = 2, C = 3, D = 4, E = 5, F = 6, G = 7, H = 8, J = 9

Silver bracket assembly with three 100E pieces in series, non magnetic with an end value of 135 pF, a WVDC of 10200 V and marked with part number code.

For capacitor values requiring more than 3 significant digits:

The capacitance code consists of the two most significant digits and an X, where "X" is separately defined.

e.g. ATC 176E23XKV2500-SK1447A

Copper bracket assembly with six 100E pieces in parallel, with an end value specified separately on the order.
In this case it could be 2340 pF, a WVDC of 2500 V and no marking.

ATC accepts orders for our parts using designations **with** or **without** the "ATC" prefix. Both methods of defining the part number are equivalent, i.e., part numbers referenced with the "ATC" prefix are interchangeable to parts referenced without the "ATC" prefix. Customers are free to use either in specifying or procuring parts from American Technical Ceramics.

Configurations and Special Test Options

Custom Assemblies

For those requirements that can not be satisfied using standard assemblies, ATC offers custom designed assemblies. Special capacitor groupings, lead configurations and hole size/spacing can be supplied to meet customers' unique requirements. Consultation with the ATC Applications Engineering staff will ensure the selection of the proper capacitors for the job provided at a reasonable cost.

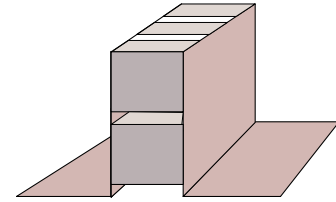

Example of 3 over 3 vertical mount construction.

Matched Sets: Series or Parallel Configurations

For customers requiring non-standard values or very close tolerance capacitance values, we can select a set of capacitors (2 or more) to achieve the desired results. The following tolerances are available:

SERIES	CAPACITANCE RANGE	TOLERANCE
* 100A/700A	1 pF to 6.2 pF 6.8 pF to 1000 pF	0.1 pF 0.5%
100B/700B	0.1 pF to 6.2 pF 6.8 pF to 5100 pF	0.1 pF 0.5%
100C	1 pF to 2700 pF	0.5%
100E	1 pF to 5100 pF	0.5%

*See complete ATC Catalog for specifications

Voltage Dividers

Voltage dividers based on capacitive reactance can be provided to customers' specific capacitance ratio. Ratios can be provided within 1.0%. An example of a 10 to 1 ratio is shown below:

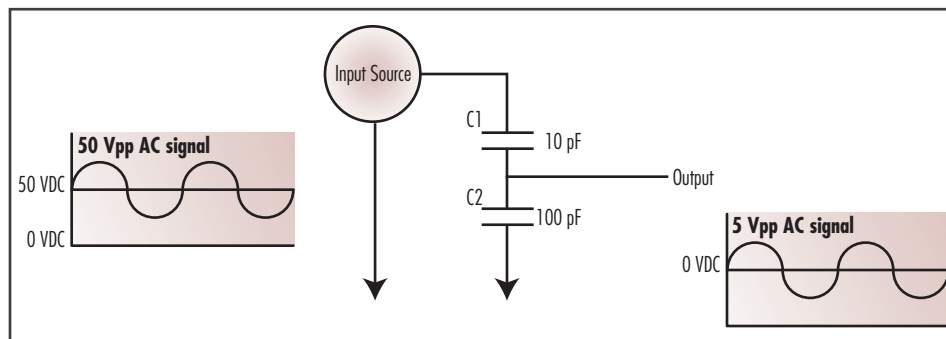

Special Test Options

- For high reliability requirements, ATC can provide enhanced screening of the individual capacitors that comprise each assembly.
- Accelerated Life Testing and Voltage Conditioning: Individual parts are tested for 100 hours at elevated voltages and at 125°C.

Individual Capacitor Specifications for Power Capacitor Assemblies

ATC 100 B Series Porcelain Superchip® Multilayer Capacitors

Capacitance Range:
0.1 pF to 1000 pF

Quality Factor (Q):
greater than 10,000 at 1 MHz

Temperature Coefficient of Capacitance (T.C.):
+90 ±20 PPM/°C (-55°C to +125°C)
+90 ±30 PPM/°C (+125°C to +175°C)

Insulation Resistance (IR):
0.1 pF to 470 pF:

10⁶ Megohms min. @
+25°C at rated WVDC
10⁵ Megohms min. @
+125°C at rated WVDC

510 pF to 1000 pF:

10⁵ Megohms min. @
+25°C at rated WVDC

10⁴ Megohms min. @
+125°C at rated WVDC

IR above +125°C is derated by one order of magnitude.

Working Voltage (WVDC):
Up to 1500 WVDC See Capacitance Values Table, page 2, ATC document # 001-807.

Dielectric Withstanding Voltage (DWV):
See ATC document # 001-807.

Retrace: Less than ±(0.02% or 0.02 pF), whichever is greater

Aging Effects: None

Piezoelectric Effects: None
(No capacitance variation with voltage or pressure)

Capacitance Drift: ±(0.02% or 0.02 pF), whichever is greater

Operating Temperature Range:
-55°C to +125°C
(No derating of working voltage)

Termination Styles:
Available in various surface mount and leaded styles. See Mechanical Configurations, page 3 & 4, ATC document # 001-807.

Terminal Strength: Terminations for chips and pellets withstand a pull of 5 lbs. min., 15 lbs. typical, for 5 seconds in direction perpendicular to the termination surface of the capacitor. Test per MIL-STD-202, method 211.

ATC 100 B Performance Data

ESR VS CAPACITANCE ATC SERIES 100, CASE B

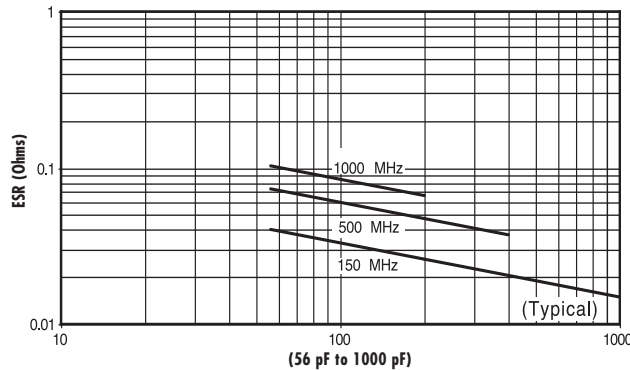

CURRENT RATING VS CAPACITANCE
ATC SERIES 100, CASE B, EXTENDED VOLTAGE

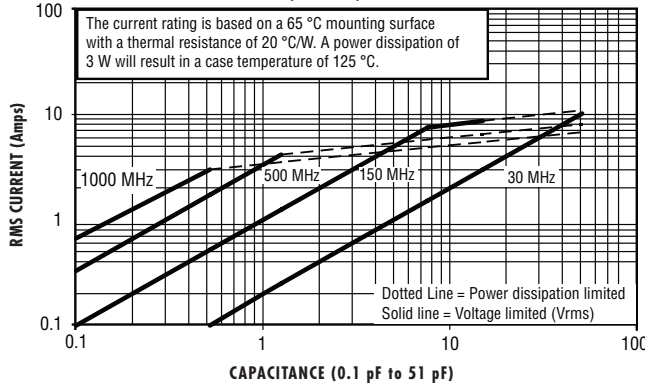

CURRENT RATING VS CAPACITANCE
ATC SERIES 100, CASE B, EXTENDED VOLTAGE

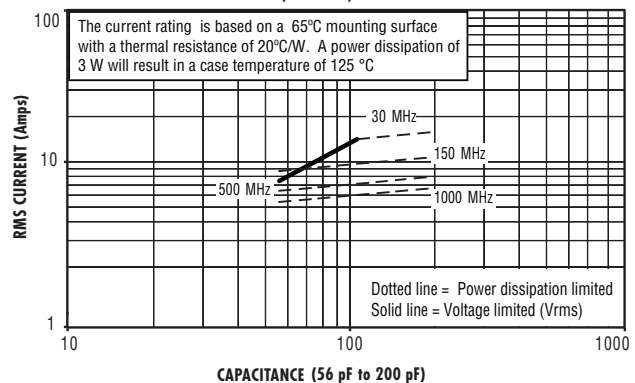

Individual Capacitor Specifications for Power Capacitor Assemblies

ATC 100 C Series Porcelain High RF Power Multilayer Capacitors

Capacitance Range:
1 pF to 2700 pF

Quality Factor (Q):
Greater than 10,000
(1.0 pF to 1000 pF) @ 1 MHz
Greater than 10,000
(1100 pF to 2700 pF) @ 1 KHz

Temperature Coefficient of Capacitance (T.C.):
+90 ±30 PPM/°C (-55°C to +125°C)

Insulation Resistance (IR):
1 pF to 2700 pF:
10⁵ Megohms min. @ +25°C at rated WVDC
10⁴ Megohms min. @ +125°C at rated WVDC

Max. test voltage is 500 VDC

Working Voltage (WVDC):
Up to 2500 WVDC. See Capacitance Values Table, page 2, ATC document # 001-808.

Dielectric Withstanding Voltage (DWV):
See ATC document # 001-808.

Retrace: Less than ±(0.02% or 0.02 pF), whichever is greater

Aging Effects: None

Piezoelectric Effects: None (No capacitance variation with voltage or pressure)

Capacitance Drift: ±(0.02% or 0.02 pF), whichever is greater

Operating Temperature Range:
From -55°C to +125°C
(No derating of working voltage)

Termination Styles: Available in various surface mount and leaded styles. See Mechanical Configurations, page 3 & 4, ATC document # 001-808.

Terminal Strength: Terminations for chips and pellets withstand a pull of 10 lbs. min., 20 lbs. typical, for 5 seconds in direction perpendicular to the termination surface of the capacitor. Test per MIL-STD-202, method 211.

ATC 100 C Performance Data

ESR VS CAPACITANCE ATC SERIES 100, CASE C

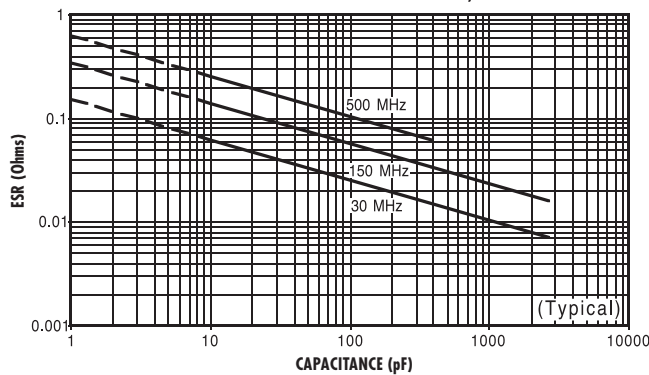

CURRENT RATING VS CAPACITANCE ATC SERIES 100, CASE C

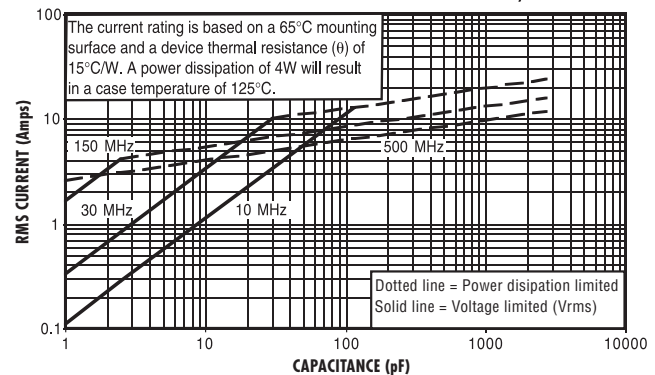

Individual Capacitor Specifications for Power Capacitor Assemblies

ATC 100 E Series Porcelain High RF Power Multilayer Capacitors

Capacitance Range:
1 pF to 5100 pF

Quality Factor (Q):
Greater than 10,000
(1 pF to 1000 pF) @ 1 MHz
Greater than 10,000
(1100 pF to 5100 pF) @ 1 KHz

Temperature Coefficient of Capacitance (T.C.):
+90 ±30 PPM/°C
(-55°C to +125°C)

Insulation Resistance (IR):
1 pF to 5100 pF:
10⁵ Megohms min.
@ +25°C at 500 VDC
10⁴ Megohms min.
@ +125°C at 500 VDC

Working Voltage (WVDC):
Up to 7200 WVDC
See Capacitance Values Table, page 2, ATC document # 001-809.

Dielectric Withstanding Voltage (DWV):
See ATC document # 001-809.

Retrace: Less than ±(0.02% or 0.02 pF), whichever is greater

Aging Effects: None

Piezoelectric Effects: None
(No capacitance variation with voltage or pressure)

CAPACITANCE Drift:
±(0.02% or 0.02 pF), whichever is greater

Operating Temperature Range:
From -55°C to +125°C (No derating of working voltage)

Termination Styles:
Available in various surface mount and leaded styles. See Mechanical Configurations, page 3 & 4, ATC document # 001-809.

Terminal Strength:
Terminations for chips and pellets withstand a pull of 10 lbs. min., 25 lbs. typical, for 5 seconds in direction perpendicular to the termination surface of the capacitor. Test per MIL-STD-202, method 211.

ATC 100 E Performance Data

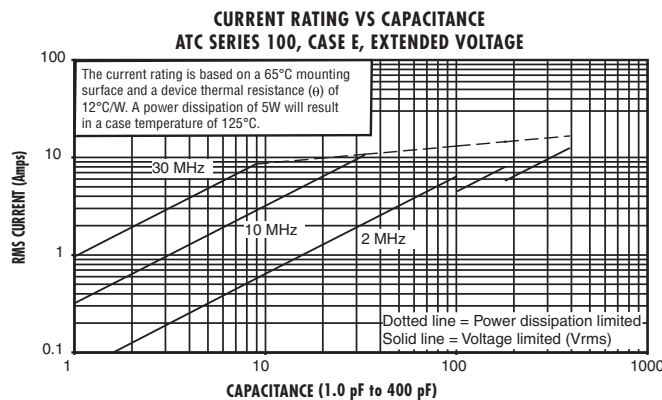
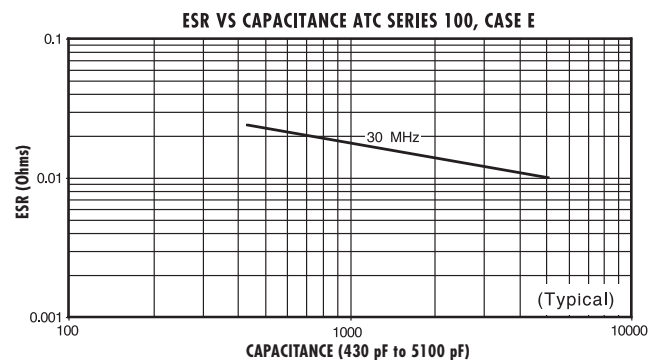
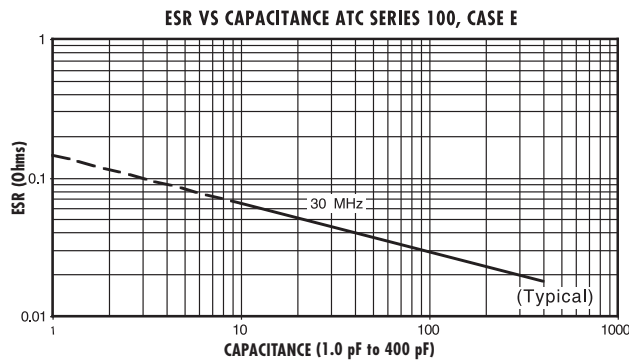

Individual Capacitor Specifications for Power Capacitor Assemblies

ATC 900 C Series Ceramic RF Power Multilayer Capacitors

Capacitance Range:

0.01 μ F to 1 μ Fd

Dissipation Factor (DF):

2.5% max. at 1 KHz

Temperature Coefficient of Capacitance (TCC):

Less than $0 \pm 15\%$ (-55°C to +125°C)

Insulation Resistance (IR):

0.01 MFd to 1 MFd

1000 megohms min. @ +25°C at rated WVDC

100 megohms min. @ +125°C at rated WVDC

Working Voltage (WVDC):

Up to 300 WVDC

See Capacitance Values Table, page 2, ATC document # 001-815.

Dielectric Withstanding Voltage (DWV):

See ATC document # 001-815.

Aging Effects:

3% maximum per decade hour

Piezoelectric Effects: Negligible

Dielectric Absorption: 2% typical

Operating Temperature Range:

-55°C to +125°C (No derating of working voltage)

Termination Styles:

Available in various surface mount and leaded styles. See Mechanical Configurations, page 3 & 4, ATC document # 001-815.

Terminal Strength: Terminations for chips and pellets withstand a pull of 10 lbs. min., 15 lbs. typical, for 5 seconds in direction perpendicular to the termination surface of the capacitor. Test per MIL-STD-202, method 211.

ATC 900 C Performance Data

ESR VS CAPACITANCE ATC SERIES 900, CASE C

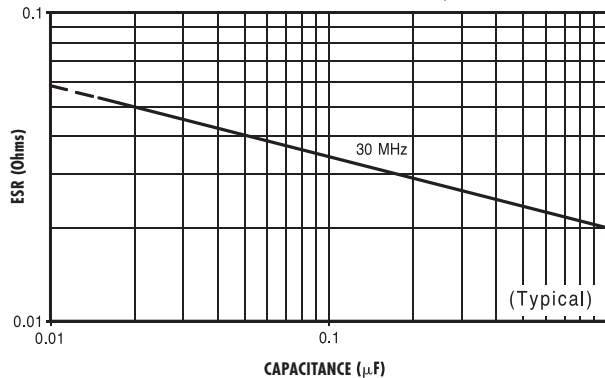

CURRENT RATING VS CAPACITANCE ATC SERIES 900, CASE C

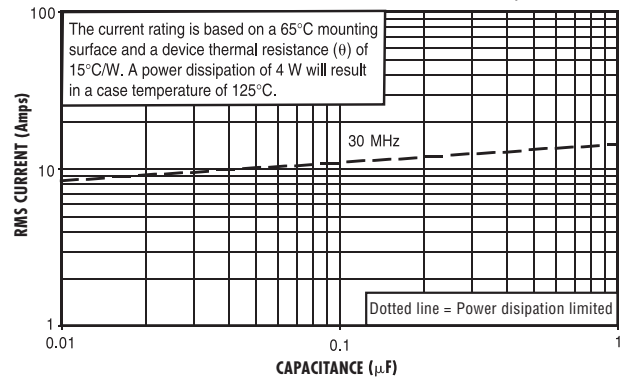

These drawings and specifications are the property of American Technical Ceramics, and any reproduction or disclosure in whole or in part as a basis for use in manufacture or sale of items is expressly prohibited without the written permission of American Technical Ceramics.

Sales of ATC products are subject to the terms and conditions contained in American Technical Ceramics Corp. Terms and Conditions of Sale (ATC document #001-992 Rev. B 12/05). Copies of these terms and conditions will be provided upon request. They may also be viewed on ATC's website at www.atceramics.com/productfinder/default.asp. Click on the link for Terms and Conditions of Sale.

ATC has made every effort to have this information as accurate as possible. However, no responsibility is assumed by ATC for its use, nor for any infringements of rights of third parties which may result from its use. ATC reserves the right to revise the content or modify its product without prior notice.

© 1998 American Technical Ceramics Corp. All Rights Reserved.

ATC # 001-900 Rev. E; 6/08



AMERICAN

ATC North America
sales@atceramics.com

TECHNICAL

ATC Europe
saleseur@atceramics.com

CERAMICS

ATC Asia
sales@atceramics-asia.com

THE ENGINEERS' CHOICE™

www.atceramics.com



ISO 9001 REGISTERED
COMPANY